

Laser Forming of Thick Steel Plates by a 2kW Diode laser with a Kaleidoscope[†]

Nobuyuki ABE*, Naoki NAKAGAWA**, Masahiro TSUKAMOTO***,
Keiji NAKACHO*, Shoji MIYAKE**** and Shuichi NOGICHI*****

Abstract

A high power 2kW diode laser system was used for laser forming of 5mm and 10mm thick steel plates. Measurements obtained with thermocouples and a thermo-viewer revealed the temperature and temperature distribution during thick plate laser forming. Finite element analysis was also performed to simulate single pass laser forming. The results were then used to determine the laser parameters for optimum irradiation. Employing these parameters, a 5mm thick plate was bent 13.5 degrees with 30 laser scans at an output power of 1 kW and a 10mm thick plate bending of 90 degrees was successfully achieved.

KEY WORDS: (Diode laser) (Laser forming) (Thick steel plate) (Temperature distribution)

1. Introduction

Compared with CO₂ and Nd:YAG lasers, diode lasers have a high energy conversion efficiency of over 40%. Recently, much higher powers and higher power densities - on a kW level and 100kW/cm² density level, respectively - have been achieved with diode lasers. Their high efficiency makes possible a smaller size oscillator, power supply, and cooling chiller unit. This is a decided advantage in the small-size manufacturing field and large-size construction field. A high power diode laser, however, has poor beam quality, which means that a short focusing distance is required for high power density. This drawback makes it more difficult to avoid the damage of the optics by strong laser plasma during deep penetration welding.

Laser forming¹⁾ utilizes a laser heat source to heat a specimen but not melt it. A small area of the specimen's surface is heated quickly and expanded. The temperature difference between the surface and bottom of the specimen causes thermal stress inside the specimen. After cooling, the

specimen is deformed because of the difference in thermal stress between the two sides. The amount of deformation is determined by the heat input. As a heat source the laser can precisely control the input power compared with other heat sources. This allows laser forming to be applied for the precise forming of various materials.

Laser forming of thick plates is a suitable application for the high power direct diode lasers because it requires high power but only a relatively low power density when compared with deep penetration welding. In this study, a high power 2kW diode laser system²⁾ was applied to laser forming of 5mm and 10mm thick steel plates. Temperature measurement with thermocouples confirmed that the temperature of the specimen determined the bending angle³⁾. The temperature distribution on the surface and the internal distribution were also found to be very important factors, as was the total heat input. In this study the temperature distribution was measured with a thermo-viewer, which revealed the strong importance of the beam profile. A kaleidoscope

[†]Received on February 1, 2002

* Associate Professor

** Graduate Student, Osaka University

*** Research Associate

**** Professor

***** Technology Research Institute of Osaka Prefecture

Transactions of JWRI is published by Joining and Welding Research Institute of Osaka University, Ibaraki, Osaka 567-0047, Japan.

was added to the diode laser system to provide a better beam profile for forming thick steel plates. Using the optimum bending parameters determined through measurement and analysis, a 5mm thick plate was bent through 13.5 degrees with 30 laser scans at an output power of 1kW and a bending angle of 90 degrees was achieved for 10mm thick steel plate.

2. Experimental Method

Figure 1 shows the configuration and size of the 2kW diode laser system used for laser forming. The maximum output power of the system is 2kW, the minimum beam diameter is 966μm, and the power density is 235kW/mm². The beam profiles at various objective distances are shown in Fig. 2. By changing the objective distance, a low power density of 10kW/cm² was obtained at the position of 58mm, 60mm and 62mm from the focusing lens. The first phase of the study was carried out using these beam profiles. In order to obtain a more uniform beam profile, a kaleidoscope as shown in Fig. 3 was added to the diode laser system. The beam profiles after addition of the kaleidoscope have a quite

rectangular shape, as shown in Fig. 4, compared with the defocused profile without a kaleidoscope. The second phase of the study was carried out using these uniform beam profiles. Figure 5 shows the relationship between input power and output power through the kaleidoscope. The efficiency of kaleidoscope was 80% which is the same as that of focusing unit.

Figure 6 shows the experimental setup. SUS304 stainless steel plates measuring 100mm x 125mm with thickness of 5mm and 10mm were used as specimens. The laser power was set at 0.6kW, 0.8W, 1kW and 1.2kW. The beam diameters for the first phase of the experiment were 2.7mm, 3.2mm and 3.5mm. The mean power density was 8.3kW/cm², 10.0kW/cm² and 13.4kW/cm², respectively. In the second phase of the experiment using the kaleidoscope, the beam profiles were 5.8mm, 7.4mm, and 8.0mm square. The displacement magnitude of SUS304 stainless steel plate after laser irradiation was measured by a laser displacement sensor. The temperatures at a distance of 7mm, 12mm and 17mm from the laser irradiation line were measured with CA type thermocouples, and the temperature distribution

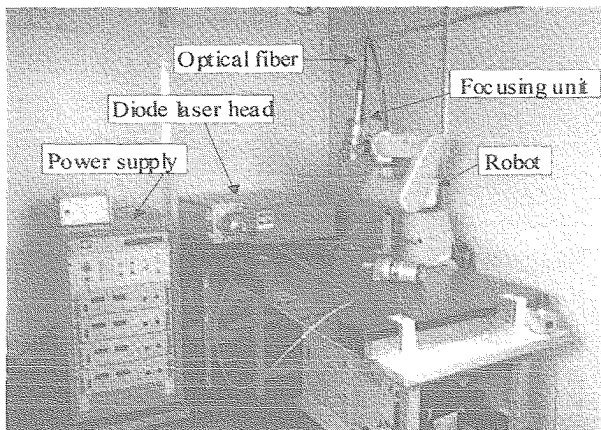

Diode laser head Wavelength: 807 and 940nm Size: 520 × 700 × 220mm Weight: 90kg	Water cooling unit Size: 560 × 730 × 1650mm Weight: 100kg
Power supply unit Output: 50V, 70A × 4 Size: 553 × 600 × 970mm Weight: 160kg	Focusing unit Focusing distance: 50mm, 60mm Weight: 0.98 kg, 2kg

Fig. 1 2kW diode laser system

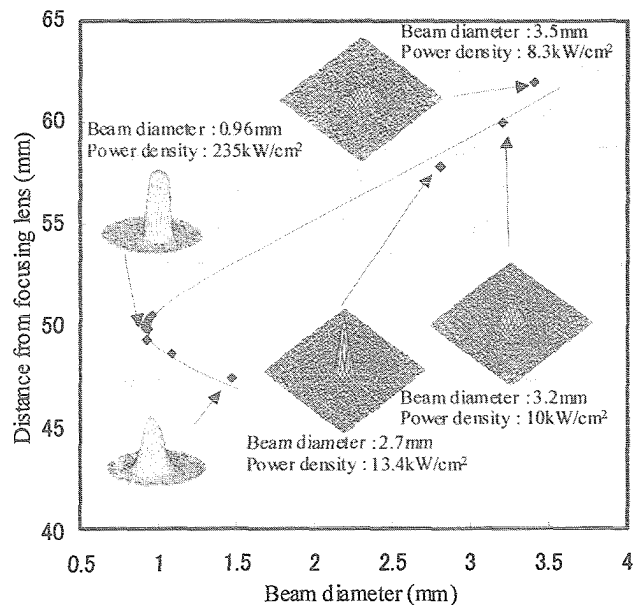

Fig. 2 Beam profiles at various objective distances

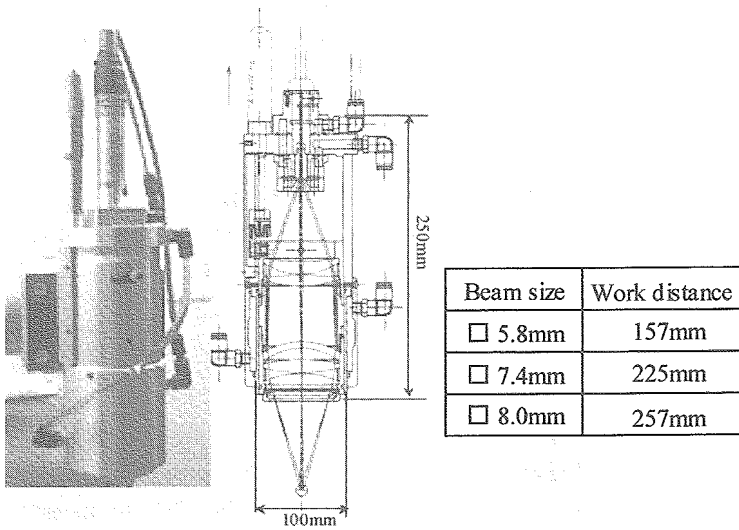

Fig. 3 Kaleidoscope

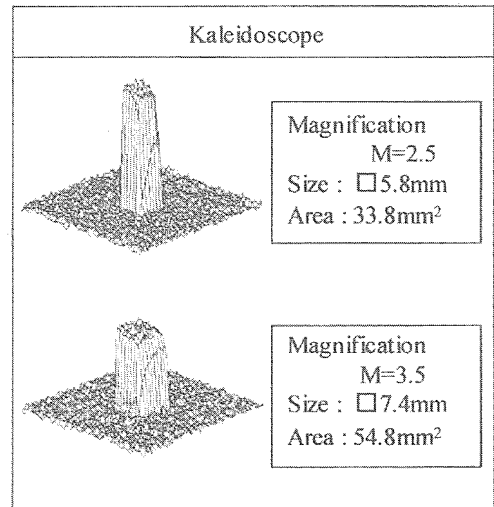

Fig. 4 Beam profiles with kaleidoscope

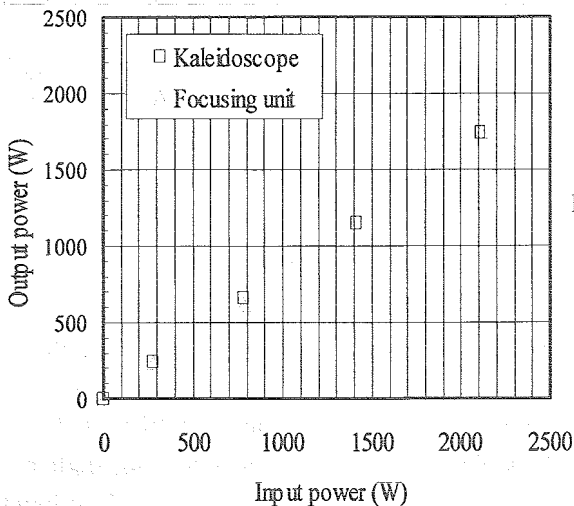

Fig. 5 Efficiency of the kaleidoscope

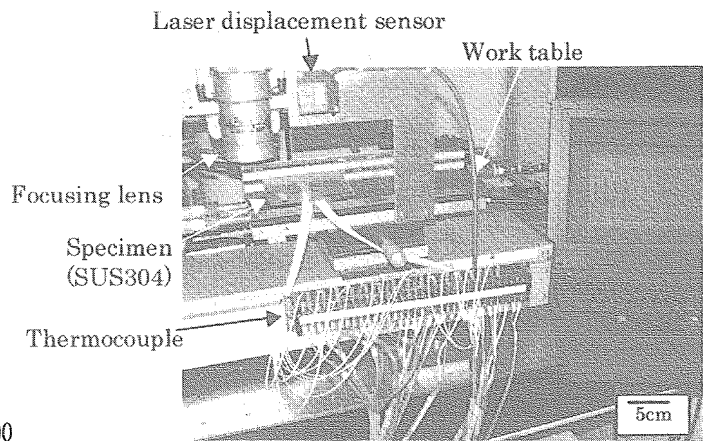

Fig. 6 Experimental setup

was measured using a thermo-viewer (Nippon Avionics Co. Ltd. TVS-8500AP).

3. Results and Discussion

3.1 Effect of temperature history on bending angle

As reported in our previous paper³⁾, the bending angle increased linearly with the number of laser scans. However, it was difficult to bend thick plates using the same laser irradiation conditions as for thin plates. To help determine the optimum irradiation conditions, the temperature of 5mm thick steel plate was measured with thermocouples at a distance of 7mm, 12mm and 17mm from the

laser irradiation line, as shown in Fig. 7. The specimen was irradiated for 4.8 seconds at a scanning speed of 1.5m/min. After irradiation, the worktable returned to the origin position in 8.2 seconds. During this period the specimen self-cooled. After 10 such scanning cycles, the specimen was cooled to 430K. Three of these 10-scan cycles were performed. The temperature of the specimen at a distance of 7mm from the laser irradiation line increased with each scan, reaching 655K after 30 laser scans. From the first to the 30th laser scan, the bending angle increased linearly to 14 degrees.

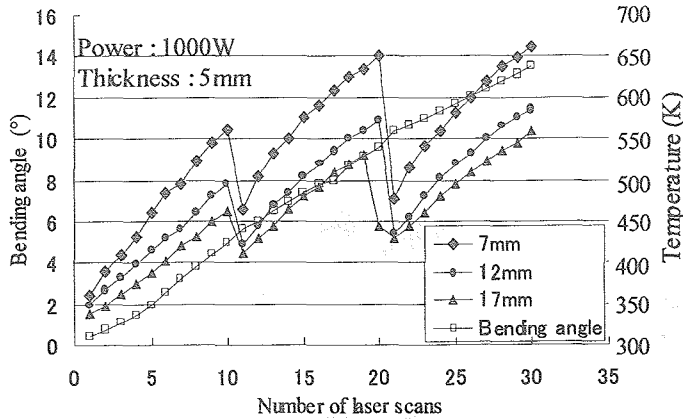

Fig. 7 Temperature history and bending angle

3.2 Effect of temperature distribution on bending angle

In order to obtain a larger bending angle for thick plates, the beam diameter dependency was examined using a thermo-viewer. The top of Fig. 8 shows the 3D temperature distribution in a 5mm thick steel plate during laser irradiation with a beam diameter of 3.5mm, 3.2mm and 2.7mm. The middle of Fig. 8 shows the 2D temperature distribution across the laser irradiation line 10mm behind the irradiation point. The bottom of Fig. 8 shows the surface appearance after irradiation.

At a beam diameter of 3.5 mm and a power density of 8.3kW/cm^2 , the too low temperature at the laser irradiation point and small surface temperature gradient across the laser irradiation line resulted in a small bending angle of only 0.9 degrees. The surface displayed a slight burn pattern. At a beam diameter of 3.2mm and a power density of 10kW/cm^2 , the temperature at the irradiation point became higher and the temperature gradient across the irradiation line became larger, resulting in a larger bending angle of 5.3 degrees. The surface still showed no melting. However, at a beam diameter of 2.7mm and a power density of 14.3kW/cm^2 , although a large bending angle of 7.4 degrees was achieved, the center of the irradiation line was melted because of the excess heat input shown in the 2D temperature distribution. The bottom of Fig. 8 shows the beam profiles for each beam diameter. The laser beam profiles for the defocused condition showed extremely

non-uniform beam shapes. At a beam diameter of 2.7mm, the beam profile was very sharp. It caused a high surface temperature at the irradiation point and melted the surface locally.

3.3 Bending of 10mm thick plate

Figure 9 shows the relationship between bending angle and the number of laser scans for 5mm thick plate and 10mm thick plate. Compared with 5mm thick plate, bending angle of 10mm thick plate was very small angle of only 0.7 degrees at the same laser irradiation condition. Figure 10 shows the 3D temperature distribution of a 10mm thick plate and the 2D temperature distribution of 10mm behind the irradiation point at a scanning speed of 1.5m/min. The temperature distribution measured by a thermo-viewer showed that there was only a small 2D temperature gradient at 10mm behind the laser irradiation point under the same irradiation conditions as those used for the 5mm thick plate - a beam diameter of 3.2mm, a power density of 10kW/cm^2 and a scanning speed of 1.5m/min. This means that the thicker specimen requires greater heat input to obtain the same temperature distribution.

In order to increase the surface temperature, the laser scanning speed was decreased to 1.0m/min. At a slower scanning speed of 1.0m/min, a temperature distribution similar to that of the 5mm thick plate was achieved and a bending angle of 1.3 degrees was obtained due to the higher heat input.

Figure 11 shows an example of laser bending of 10mm thick SUS304 stainless steel at an output power of 1kW with 50 laser scans at a scanning speed of 1.0m/min. With a sufficient heat input and rise in temperature, a bending angle of 6.1 degrees was achieved

3.4 Laser forming with a kaleidoscope

From the above discussion, it becomes clear that the beam profile and heat input are the most important factors for laser forming of thick plates. In order to utilize a beam with a uniform power density distribution, a kaleidoscope was attached to the diode laser system.

Figure 12 shows the bending results for the

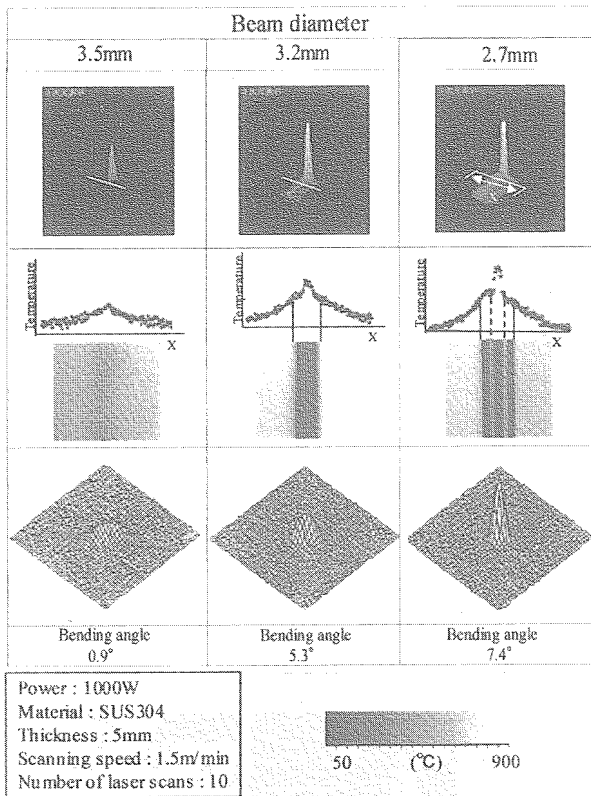

Fig. 8 Temperature distribution and surface appearance of 5mm thick specimen

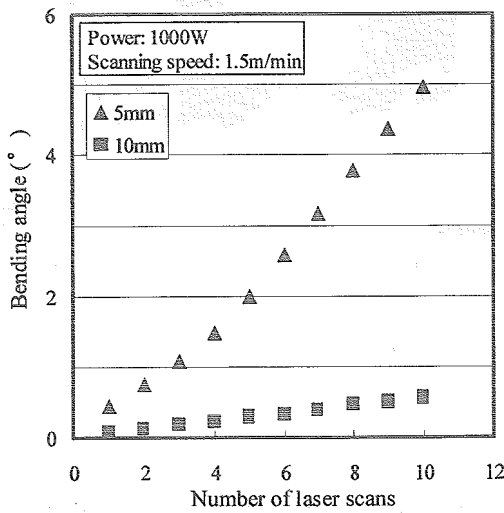

Fig.9 Bending dependency on plate thickness

same beam size at different powers. When the beam size was the same, a lower power beam produced a larger bending angle because the low power density enabled a low scanning speed without surface melting, resulting in a longer heating time, higher heat input and higher

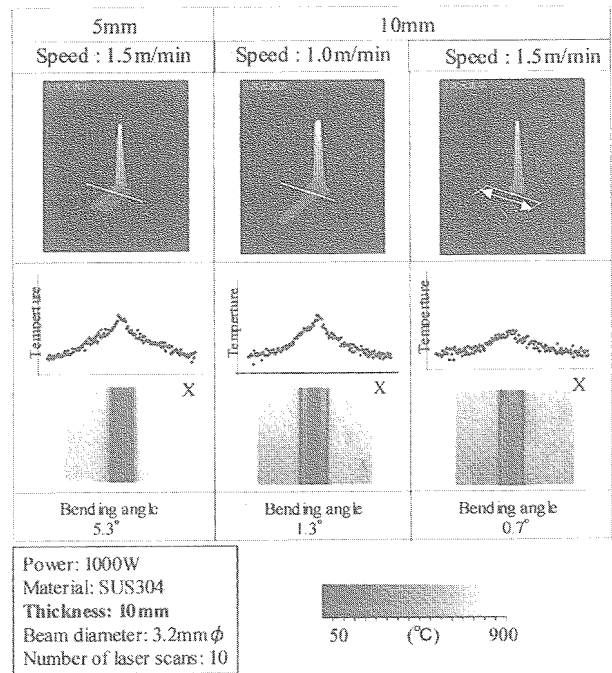
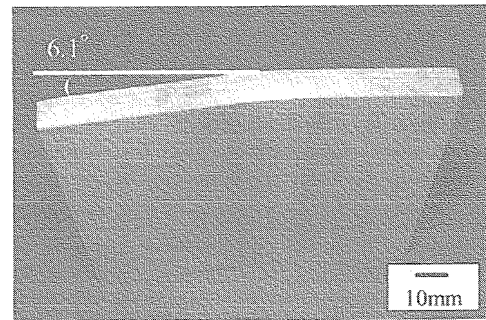

Fig. 10 Temperature distribution of 10mm thick specimen



Laser Power: 1000W Material: SUS304 Thickness: 10mm Scanning Speed: 1.0m/min Number of laser Scans: 50

Fig. 11 Example of 10mm thick steel plate bending

temperature. On the other hand, when the laser power was the same, a larger beam size produced a larger bending angle as shown in Fig.13, because the low power density similarly resulted in a higher temperature and higher heat input to the specimen.

After clarifying that a larger beam size and a slower scanning speed increased the bending angle of thick plates, a beam size of 8.0mm and a scanning speed of 0.54m/min were employed to bend 10mm thick SUS304 stainless steel.

Figure 14 shows the results. The laser power was 0.95kW, the number of laser scans was 10 and

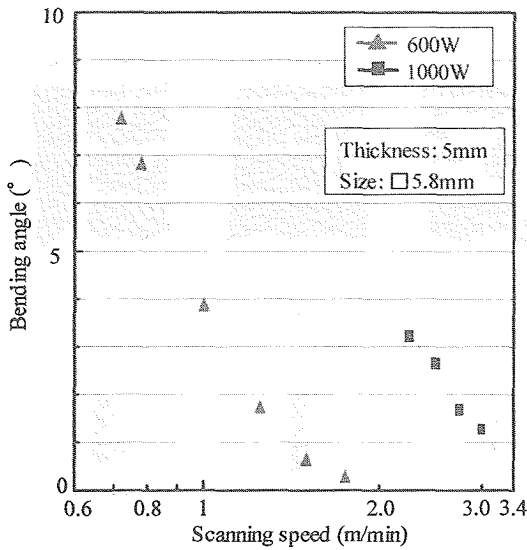

Fig. 12 Bending angle dependency on beam power

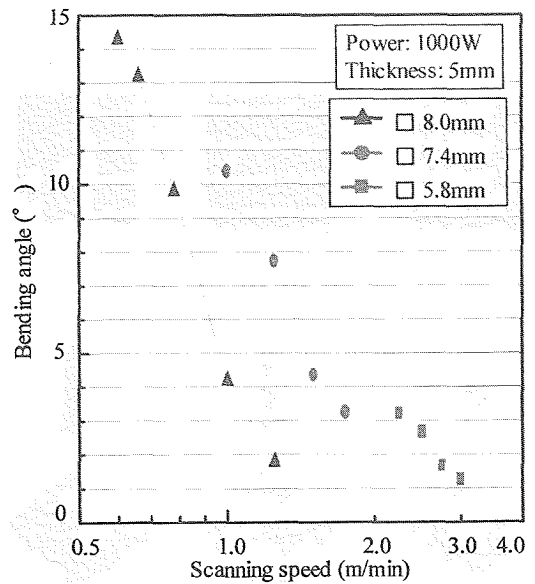

Fig. 13 Bending angle dependency on beam size

there were 36 irradiation lines with separation of 4.5mm. A bending angle of 90 degrees was successfully achieved for 10mm thick steel plate.

4. Conclusions

In order to apply a high power direct diode laser system to laser forming of thick steel plates, the relevant irradiation parameters such as the beam size, the power density, the scanning speed, the heat input, the temperature and the temperature distribution were individually examined. The most important factor was determined to be the beam profile. A kaleidoscope was introduced to obtain a uniform beam profile and to ensure suitable temperature distribution. The heat input was also an important factor for thick plate forming. In order to avoid surface melting, a lower power density was found to be better for obtaining higher heat input to the specimen. The large beam size and the slow laser scanning speed resulted in a larger bending angle of thick plate. Based on these results, a bending angle of 90 degrees was successfully achieved for 10mm thick SUS304 stainless steel plate.

Acknowledgement

The authors wish to express their many thanks to Mr. T. Mamezuka for his important contribution in performing the experiments.

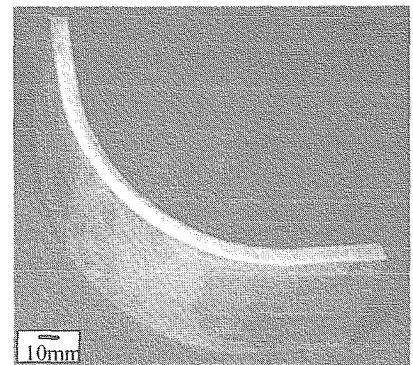

Specimen: SUS304 Thickness: 10mm Power: 950W
Scanning speed : 0.54m/min Laser scan: 10 × 36

Fig. 14 Example of 10mm thick steel plate bending performing the experiment

References

- 1) Y. Namba: Laser Forming of Metals and Alloys, Proc. of LAMP'87, Osaka, 1987, pp.601-606.
- 2) N. Abe, R. Higashino, M. Tsukamoto, S. Noguchi and S. Miyake: Materials Processing Characteristics of a 2kW Class High Power Density Direct Diode Laser System, Proc. of ICALEO'99, San Diego, 1999, pp.A236-244.
- 3) N. Abe, R. Higashino, N. Nakagawa, M. Tsukamoto, S. Noguchi and M. Hayashi: Welding and Forming of Thick Steel Plates with a High Power Density Diode Laser, Proc. of ICALEO2000, Dearborn, 2000, pp.16-23.